

# RTO Series Temperature Recorders & Recorder Controllers

RTO-2003

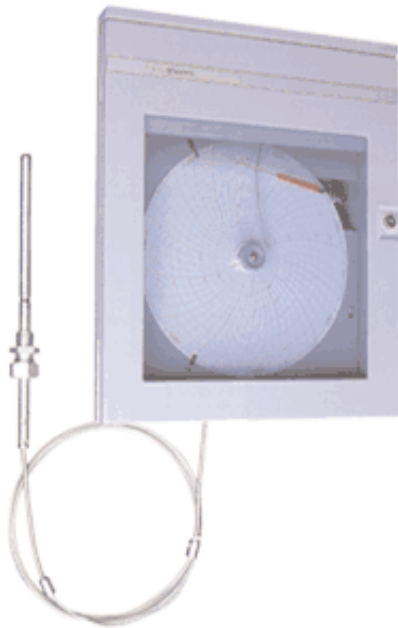

## Standard Temperature Ranges

Range	System Filling	Range	System Filling
-40 to +40°C	f	0 to 160°C	f
-30 to +30°C	f, m	0 to 200°C	f, m
-30 to +50°C	f, m	0 to 300°C	f, m
-25 to +25°C	f, m	0 to 400°C	f, m
-25 to +30°C	f, m	20 to 120°C	f, m
0 to 40°C	f, m	50 to 150°C	f, m
0 to 50°C	f, m	50 to 250°C	f, m
0 to 60°C	f, m	100 to 400°C	f, m
0 to 100°C	f, m	100 to 500°C	f, m
0 to 120°C	f, m		

key f = non toxic filsafe m = mercury

The filled system range of temperature circular chart recorders uses the well proven and reliable Rototherm stainless steel thermal system.

These reliable and accurate instruments are suitable for most applications where there is a requirement for low cost temperature recording.

Up to 3 pens can be fitted with three temperature systems or combination of temperature, pressure or flow sensing systems.

### FEATURES

- 1, 2 or 3 pen temperature recording and controlling at low cost
- Uses proven and reliable Rototherm filled temperature systems
- Simple installation and maintenance requirement
- Portable stand or pipe mounting available
- Fully mechanical versions available
- Electrical, battery or mechanical chart drive options
- Electrical control options
- Pneumatic control options

### Pens

Fitted to the pen arms are disposable fibre tipped pens which are readily replaced without mess. Single pen recorders and the first pen of the two and three pen recorders trace in red ink, the second pen in blue, the third in green.

### Control Options

Full pneumatic control is available on this range of recorders - for full details please refer to the Pneumatic recorder controller data sheet.

Electric Control / Alarm - One and two pen recorders in this range may be specified with electrical control options.

## Dimensions & Fixings

### PORTABLE

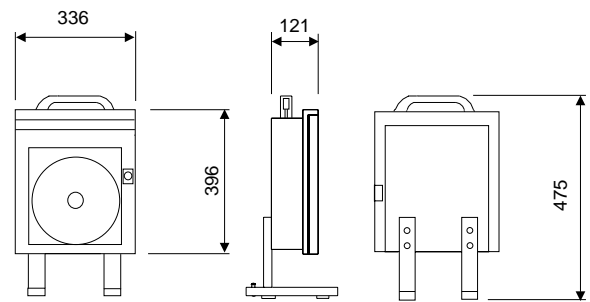

### SURFACE MOUNTING

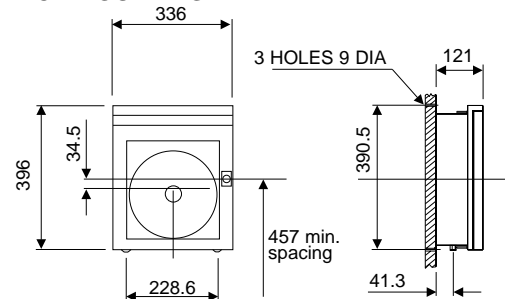

### PANEL MOUNTING

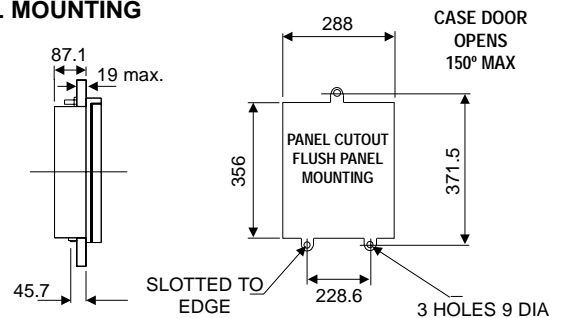

All dimensions are in mm. Drawings are for illustration purposes only.

## Specifications

### ACCURACY

+/-1% FSD

### AMBIENT TEMPERATURE

-20°C to +50°C

### MEASURING ELEMENT

Rototherm thermal bourdon tube temperature compensated.

### CAPILLARY

Microbore stainless steel tube with 3mm diameter stainless steel cover (type C1) as standard. Other capillary types are available.

### BULB AND STEM

Stainless steel BS970 316. Standard diameter is 12.7mm.

### FITTINGS

Compression gland (adjustable). Stainless steel BS970 316 (1/2" BSP is standard). Other BSP, NPT and API are available on request. (suitable for pressures up to 3.5 bar)

### CHART DRIVE

Synchronous electric, battery or mechanical spring wound. 24 hour or 7 day. (other rotations on request)

### CHARTS

Disc 240mm (9.5 inches) diameter. Standard dividing 40, 50, 60, 70 or 80 linear divisions.

### INKING SYSTEM

Disposable fibre tipped pens.

Single pen : Red.

2 pen : red & blue.

3 pen : red, blue and green.

### CASE

Glass filled polyester resin. protection rated to IP55

### WINDOW

Acrylic

### POWER SUPPLY

200 to 250 volts, 50Hz (60Hz available); 100 to 110 volts, 50Hz (60Hz available);

Instruments without electrical control require no power supply provided that a clockwork chart drive is fitted. Battery operated chart drives require 1.5 volt type "C" cell.

### ELECTRICAL ALARM AND CONTROL

Contact rating (when fitted):

0.1A at 250V AC (non inductive)

0.01A at 250V DC (non-inductive)

Relay contact rating: 10A at 250V 50Hz

Contact adjustment range : 2% to 100%

### MOUNTING

Suitable for surface or panel mounting. (Pipe mounting and portable options available)

### WEIGHT

Single pen : 6.5 kg (14.25lb)

Two pen : 7.0 kg (15.5lb)

Three pen : 7.5 kg (16.75lb)

The above weights include 3 metres of capillary. For each additional 3 metres add 0.25kg (0.5lb)

## Bulb Types

### Type 301

This bulb is used when no fitting is required. The bulb may be held in place by a bracket or a clip (not supplied by Rototherm).



### Type 302

This bulb has a fitting which slides along the capillary and is tightened into the required position. Bulb length cannot be specified.

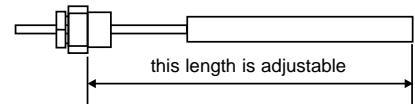

### Type 303

The fitting is located on the bulb. When ordering please confirm immersion length "L".

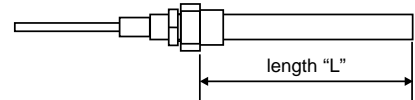

## Compression Glands/Fittings

Compression glands tighten on stem to provide liquid and gas tight seal. Once fitted the position of the thermometer can only be altered by cutting off the olive and replacing it with a new one.

Add 50mm for BSP threads (75mm for NPT threads) to desired immersion length to obtain minimum "D" dimension).

Compression glands are available on type 302 and 303 bulbs only.



## World-Wide Reliability & Quality

Rototherm's high quality and performance is guaranteed by an uncompromising approach to quality. British Rototherm's policy has always been to maintain a consistently high level of quality and reliability throughout its product range and serve to customers. The company has worked energetically towards establishing comprehensive quality controls and has earned a world-wide reputation for product quality.



ISO 9001

## Ordering Codes

- 1 pen RTO
- 2 pen RTO
- 3 pen RTO

RTO 10																				
RTO 20																				
RTO 30																				

- MOUNTING**  
 Wall/Panel  
 Portable  
 Pipe

- CHART DRIVE**  
 Electric 240V 50Hz  
 Electric 110V 50Hz  
 Electric other\*  
 Spring Wound  
 Battery

- CHART ROTATION**  
 24 hour  
 7 day  
 Other\*

- CONTROLS / ALARMS**  
 No control  
 1st pen                      High & Low  
 2nd pen                     High & Low  
 1st & 2nd pen            High & Low

- FILLING MEDIUM**  
 Mercury  
 Non-Toxic Filsafe

- BULB OPTION**  
 Type 301  
 Type 302  
 Type 303  
 Other\*

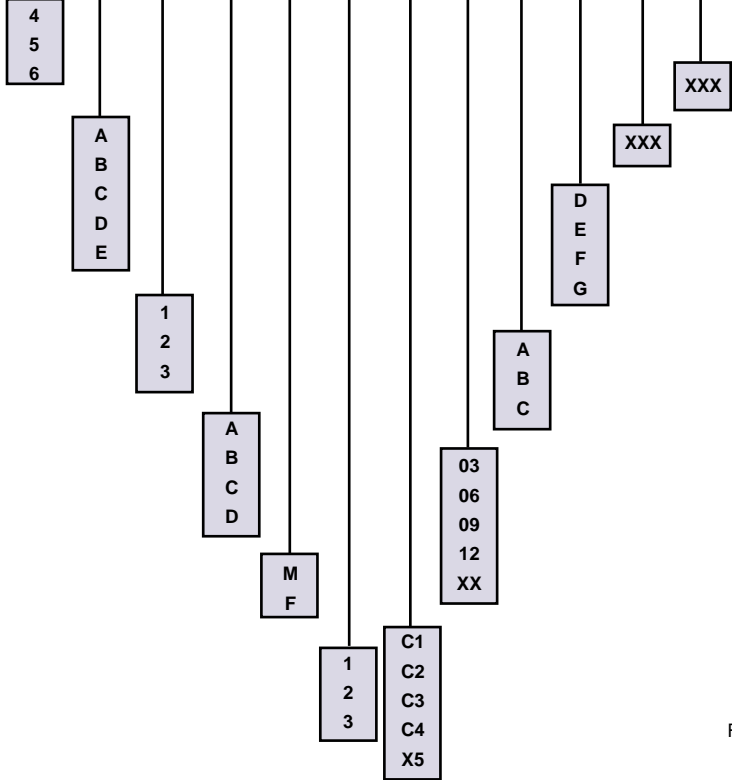

- RANGE** (specify °C or °F)
- IMMERSION LENGTH "L"**  
(Length in mm)
- GLAND MATERIAL**  
 No gland  
 Mild steel  
 Stainless steel  
 Other\*
- FITTINGS/GLAND**  
 No fitting  
 Gland 1/2" BSP  
 Other\*
- CAPILLARY LENGTH**  
 3 metres (standard)  
 6 metres  
 9 metres  
 12 metres  
 Other\* (enter length in metres)
- CAPILLARY**  
 Stainless steel  
 Copper  
 Flexible stainless armour  
 Flexible stainless armour over stainless  
 Other\*

**Example Ordering Code**  
 Single pen temperature recorder, wall mounted, electrical 240 volt 50hz chart drive, 24 hour rotation, non-toxic Filsafe filling, type 303 bulb, 3 metres of stainless steel capillary, immersion length 150 mm, range 0 to 200 Deg C.

**RTO 10 4 A 1 A F 3 C1 03 A D 150 0-200°C**

Notes  
 (a) Where Other\* is specified please add note to order code stating exact requirements  
 (b) Should a combination of Pressure & Temperature be required please refer to the pressure recorder data sheet.  
 (c) When specifying different ranges for 2 or 3 pen recorders, care should be taken to use standard/compatible charts ranges.

**Other Recorders & Controllers Available include:**

- **Temperature & Pressre Combined**
- **Temperature & Humidity**
- **Pressure & Differential Pressure**
- **Flow**
- **Level**
- **Electric Input Recorders - including programmable recorders**
- **Pneumatic Recorder Controllers**