

# IMP 3595 & 5000 Series

## Isolated Measurement Pods

Data sheet  
IP9001

Solartron's IMP Family presents the complete solution to your distributed measurement problems.

The IMP concept is simple: plant parameters - such as temperature, strain, pressure, etc. - are measured at source by intelligent data acquisition modules (IMPs). Every IMP (Isolated Measurement Pod) is linked on a low cost network (carrying control, data *and* power) or, in the case of the E-IMP, by Ethernet or RS 485, to a host computer which controls the IMPs and stores and displays the measured data where it is needed - in the control room, on the shop floor, or at any other strategic location.

The IMP system gives you precisely the information you need to control and monitor your plant, with maximum reliability, maximum flexibility and at very competitive cost.

**Precise...** IMPs offer accurate, high precision (16-bit) measurements with excellent noise immunity and common mode isolation, even in areas of high electrical interference and vibration. Built-in facilities enhance measurements on thermocouples, PRTs and strain gauges.

**Reliable...** With an operating temperature range of -20°C to +70°C (-4°F to +158°F) even at 95% humidity, and a rugged housing meeting IP55 / NEMA 4 standards, IMPs are built to work under harsh conditions. Whether your plant is hot, dirty, cold or wet - or all four! - we offer a full 3-year warranty on every IMP.

**Flexible...** Installing the 2-wire multidrop network (S-Net) couldn't be simpler, and modifications can be made in minutes. IMPs can be rapidly added or removed when required, without the need for

extensive rewiring. Alternatively, where Series 5000 IMPs are used, the communication network is either Ethernet or RS485, or both. IMP systems can range from a few IMPs on a single S-Net to multiple networks with many thousands of channels.

**Cost effective...** IMPs contain everything you require for precise, reliable data acquisition. What you get is all you need - there's no necessity for expensive signal conditioning, filters, amplifiers, transducer wiring, vibration mounts, environmental packaging, special power supplies or expensive network hardware. There are no hidden costs with IMPs!

With over 30,000 IMPs in operation throughout the world, in daily use by many of the world's most successful companies, there is no doubt that Solartron's IMP family is unique.



## Coming to terms with the technology

**IMP (Isolated Measurement Pod)** is a complete data acquisition module containing: signal conditioning, 16 bit ADC, communications to host computer, built-in sensor energisation and a detachable connector block, all housed in a NEMA 4 / IP55 environmentally protected case and built to ISO 9001 standards.

IMPs can make precise measurements of dc voltage, current, temperature (direct from thermocouples or PRTs), resistance, 4-20mA signals, strain, pressure, frequency, pulse counts, events and status, under the control of the internal processor, as directed by commands from the host computer.

**IMC (Isolated Measurement Card)** All IMPs are available without the NEMA 4 packaging, suitable for high channel-count monitoring in less demanding environments, such as an instrumentation area or in the control room.

**S-Net** is Solartron's high-speed industrial digital communications network that is used for control, power and data communications with IMPs or IMCs to the host computer. A single S-Net can be up to 1.5km (1 mile) long, with up to 50 IMPs multidropped along its length.

It provides excellent noise rejection with transparent error correction, and can handle up to 1,000 channels per second. S-Net cable needs only two conductors, reducing the cost of the overall installation.

**Ethernet** With the increasing use of Ethernet as a plant-wide transmission medium, the 5000 IMP provides direct connection to the Ethernet hub. Alternatively, 5000IMPs can be multidropped on an RS485 network with one IMP providing pass through facilities to the Ethernet.

**IP55 / NEMA 4** Equipment meeting these environmental specifications must be protected against damage and malfunction caused by the ingress of harmful dust, water from a jet-spray or the formation of ice on their casings. IMPs fully meet the specifications, to ensure that they will function perfectly in whatever conditions they are used.

**Host Computer** issues commands to IMPs and receives measurement data via one or more S-Nets. There are S-Net Interfaces for a variety of computers, handling all communication protocols and error checking. Application software for the storage, manipulation and display of data is available from Solartron as well as from our Value Added Resellers (VARs) and can be a standard product, or customised for your specific needs.



## Hardware, Software or complete Systems Integration

The flexibility of the IMP family and the huge range of applications means that no one supplier can fully meet the needs of every user. Solartron's policy is to work with Value Added Resellers (VARs) and Systems Integrators in order to ensure that you receive the best possible support for your complete system. Together with our network of business partners we can supply data acquisition systems across a whole spectrum of applications - from low cost 'off the shelf' packages to fully customised systems capable of measuring many thousands of channels.

A separate brochure listing our business partners is available; contact your local Sales Office for a copy.

The IMP Family ... includes ten different IMPs to tackle virtually any plant monitoring requirements.

IMP Type	3595 1A	3595 1B	3595 1C/1E	3595 1D	3595 1H/1J	3595 2A	3595 2B	5000 1E
No. Channels	20	10	20	4	18 2	20	32	20
Volts dc	I	I	I		I			I
Resistance		I			I			I
Current dc	I		I		I			I
Thermocouple	I		I		I			I
PRT (RTD)		I			I			I
Strain		I						
Status					I	I	I	I
Frequency					I	I		
Period					I	I		
Events						I	I	
Counts					I	I		
Digital O/P					I	I	I	
Current O/P				I				
Voltage O/P				I				

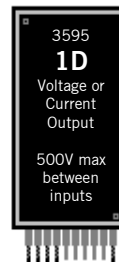
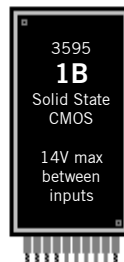
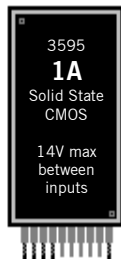

Each IMP has:

20 channels of 3 pole switching

DC Volts:  $\pm 12V$

DC Current: 0 to 20 mA (with 100 $\Omega$  shunt)

Thermocouple linearisation: types B,E,J,K,N,T,R,S

Cold Junction Compensation for thermocouples

Each IMP has:

10 channels of 6 pole switching

DC Volts:  $\pm 2V$

Strain:  $\frac{1}{4}$ ,  $\frac{1}{2}$  & full bridge

Resistance: 0 to 2.5K $\Omega$

PRT: 0 to 100

Single and dual current operation

Each IMP has:

4 channels

Volts out:  $\pm 10V$

Resolution: 5mV

Current out: 0 to 20mA

Resolution: 10 $\mu A$

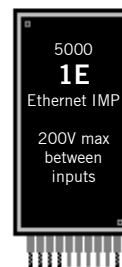
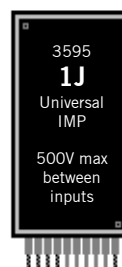
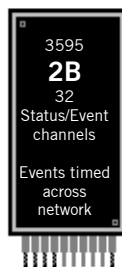
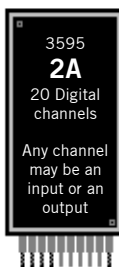

Each IMP has:

20 digital channels

Status/Events: 1ms resolution

Frequency: 0.1Hz to 49kHz

Period: 20 $\mu s$  to 25s

Count: >16 million

Each IMP has:

32 Status/Event channels

Status/Events: 20ms resolution

Watchdog: hardware and software

Each U-IMP has:

18 Multifunctional analogue/digital inputs

DC Voltage:  $\pm 12V$

DC Current: 0 to 20mA

Thermocouples: Types B,E,J,K,T,R,S

PRT: 100 $\Omega$  Pt or 10 $\Omega$  Cu

Resistance: 2-, 3- or 4-terminal

Each E-IMP has:

20 Multifunctional analogue/status inputs

DC Voltage:  $\pm 12V$

DC Current: 0 to 20mA

Thermocouples: Types B,E,J,K,T,R,S

PRT: 100 $\Omega$  Pt or 10 $\Omega$  Cu

Resistance: 2-, 3- or 4-terminal

Status

Network: Ethernet or RS 485

## Technical Description

### Physical

Each IMP consists of a sealed case containing a measurement module and a separate connector block that slides into the main IMP housing and is screwed securely in place. This enables an IMP to be removed easily for recalibration without the necessity to rewire any of the transducer and network connections. All connections are made by screw terminals.

IMP cases meet NEMA 4 / IP55 standards for enclosures: when installed correctly they will withstand dirty and dusty atmospheres and water from a jet-spray. Built from aluminium and finished with epoxy paint, they are also highly resistant to corrosion. IMPs can also operate in temperatures as low as -20°C (-4°F), and as high as 70°C (158°F).

### ***Whether it's hot, cold, dirty or wet - IMPs can take it!***

### Electrical

At the heart of every IMP is a microprocessor that responds to commands received from the host computer. The processor controls the measurement setup and data acquisition and communicates data and other responses to the host. Measurements are stored within the IMP until required by the host. IMPs have a low power requirement and can be powered directly from the host computer when used on an S-Net communications network. However, depending on the number of IMPs on an S-Net, and the length of the S-Net cable, it may be desirable to power IMPs from a local dc power supply. (E-IMPs must always be powered locally.) S-Net cabling is available from leading cable manufacturers or from Solartron in a range of gauges. The choice of gauge depends on the type of power supply, the number of IMPs to be used, their distribution along S-Net and the distance to be covered.

For additional details a publication is available "Communication Cable Selection for IMP Networks" either from your local agent or from our website [www.solartronmobrey.com](http://www.solartronmobrey.com)

### Analogue Measurements

There are seven analogue measurement IMPs, each with a precision integrating pulse width, auto ranging 16 bit ADC for measuring signals at microvolts levels. Integration times are selectable for excellent noise rejection in 50Hz or 60Hz environments or for faster acquisition rates. To maintain the highest accuracy and linearity, drift correction to all ranges is applied automatically between scans. Results, converted to engineering units when required, are buffered ready for transmission back to the host computer. Buffering allows continuous operation to achieve maximum data throughput.

Calibration is made easy with our calibration connector kits. New calibration values are stored in the IMP's non-volatile memory.

All IMP channels are independent so that transducer and measurement types can be different for every channel, if required.

The 3595 1A contains a solid state CMOS FET switch for low voltage applications. The 3595 1C, 1E, 1H, 1J and 5000 1E contain reed-relays that are ideal for applications requiring high inter-channel isolation; for example, working in parallel with an existing plant indicator or control system. The 1E and 1J, with their 500 volt isolation, are becoming popular for use in areas with large electrical fields. Both the 1C and 1E can measure up to 250 volts with the optional high voltage connector (3595 3D).

The 3595 1B contains 10 channels of 6 pole solid state CMOS FET switches and is specifically designed for use with PRTs, strain gauges and other resistance-based transducers.

For accurate 4-wire resistance measurement single current energisation is used. For strain gauge applications dual current energisation is used in order to eliminate balance and sensitivity controls - and the special signal conditioning - that is normally required.

The 3595 1H and 1J, as well as the 5000 1E, provide 6 pole switching with reed relays. Resistance is measured using either 2-, 3-, or 4-wire connections.

### Analogue Output

The 3595 1D is an analogue output (voltage or current) IMP that is suitable for applications requiring supervisory or direct control, or with remote panel meters and strip chart recorders. Voltage can be controlled over the range  $\pm 10V$  and current in the range 0-20mA or 4-20mA. Initial values on power-up are selectable.

## Digital Measurements

There are two digital IMPs, the 3595 2A and 2B. The 2A has 20 channels, any of which may be configured as inputs with TTL or "12V" thresholds, or FET switched outputs. It can be used to measure status, frequency, period, and incremental or totalising counts. It is ideal for almost all types of transducers with pulse outputs, such as flowmeters or speed sensors. Events can be timed to within 1ms anywhere across the whole IMP network, enabling an accurate picture of sequential events to be logged. A built-in supply can be used for "volt free" inputs, and to provide TTL output levels.

The 2B provides 32 transformer-isolated input channels, four of which can be configured as FET switched outputs. Each input, which can be measured as voltage or resistance, is sampled every 20ms to determine its status; transitions (positive, negative or both) are logged and transmitted to the host. Events are timed across the entire network with a resolution of 20ms. The IMP also includes a hardware and software watchdog on channel 32 which can be used to detect a failure within the IMP, or with the host / S-Net if a status message is not received within a programmable timeout period.

## Combined analogue and digital IMPs

Three IMPs, combine most of the measurement facilities of the standard IMP range into single packages, offering a staggering choice of measurement possibilities in each Pod.

**The Universal IMPs** 3595 1H and 3595 1S offer tremendous potential for system designers to create flexible and cost effective solutions in a wide variety of SCADA, C & I and DAS environments. With 18 multifunction analogue/digital inputs, and two dedicated digital I/O channels, they are ideal in applications such as front-end alarm monitoring and control, where they overcome the need for two separate IMPs, reducing cabling costs, increasing channel utilization, and opening up possibilities which were previously impractical. In addition to all the normal advantages of the IMP family, the Universal IMPs have additional features designed to enhance system reliability and performance:

- ▶ **Large data memory** ensures that no data is lost during temporary failure of host computer. Result storage: 19,200
- ▶ **Autonomous alarm checks** Even if the host PC or DCS fails, digital outputs can still be triggered by alarm levels on analogue inputs - ideal for low cost machinery protection systems

The 3595 1H combines the dc voltage, current and thermocouple temperature measurements of the 3595 1C, the resistance and PRT capability of the 3595 1B with the digital performance of the 3595 2A. Similarly, the 3595 1J combines the specification of the 3595 1E with the 3595 1B and the 3595 2A.

**The Ethernet IMP** 5000 1E is the ideal solution for distributed monitoring in plants using Ethernet as the communications network. It provides precise, accurate measurements of any parameter to a host computer, plant DAS or DCS via low cost Ethernet connections - no matter what the environment.

## 10baseT Ethernet-Hub technology

E-IMP uses standard off-the-shelf Ethernet devices, so the cost of installation is drastically reduced, and existing on-site IT staff can provide network support.

## Modbus/RS485 bus multi-drop

The E-IMP can communicate on either Ethernet or RS485 networks. In addition, pass through control enables the E-IMP to act as an Ethernet node for a multi-drop (RS485) Modbus network: a highly cost effective method for integrating Modbus devices into the plant network.

## Portable Measurement

Connect an E-IMP directly to a portable PC with a standard Ethernet printer (crossover) cable. Instant high quality data i/o with no interface cards and no hub – ideal for field applications!

The 5000 1E combines the analogue measurement capability of the 3595 1E with the resistance and PRT capability of the 3595 1B. any channel can also be used for status measurement.

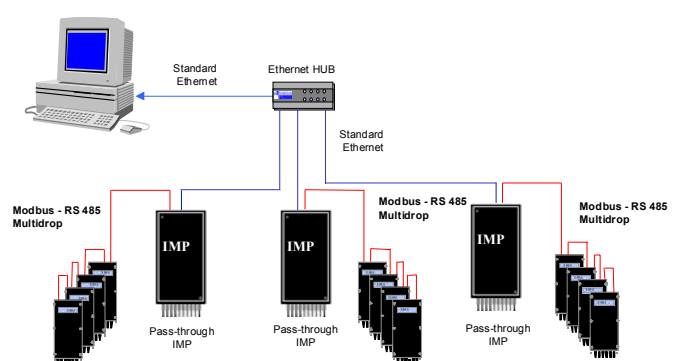

**Specifications - IMPs and IMCs**

Power supply:	10V to 50V dc. (E-IMP 10V to 24V dc)
Power feed:	via S-Net cable or IMP terminals
Power consumption of	
each IMP:	<1.2Ω*, U-IMP <1.7Ω, E-IMP 4Ω
Results returned from	
all IMPs on S-Net:	<1s
Isolation, IMP to IMP, IMP to	
Ground, IMP to S-Net:	500V (E-IMP 200V)
Analogue to digital converter:	15 bits + sign
Analogue scanner leakage	
currents at 25±3°C (77±5°F):	
3595 1A/1B:	<60nA
3595 1C/1E/1H/1J, 5000 1E:	<15nA
Analogue IMP:	
Input impedance:	>10GΩ
Channel Crosstalk:	>120dB
Analogue IMC:	
Input impedance:	>10GΩ
Channel Crosstalk @ RH <50%:	>120dB
Channel Crosstalk @ RH <75%:	>100dB

\*The 3595 1D can consume more in certain circumstances – see specification page

**Safety**

Low voltage directive: EN61010

**EMC/RFI**

EN61326:1997

**3595 1A and 3595 51A Analogue Measurement IMP/IMC**

Number of channels:	20
Switching:	solid-state, 3-pole
Maximum signal measured:	±12V
Overload protection, continuous:	50V
Max voltage between any input and any guard:	14V
Common mode, between IMPs:	500V
Mean Time Between Failures, to MIL 217E:	137,000 hrs (IMP) 146,000 hrs (IMC)

**3595 1C, 3595 1E, 3595 1H, 3595 1J, 5000 1E Analogue Measurement IMPs  
3595 51C and 3595 51E, 51H, 51J Analogue Measurement IMCs**

Number of channels:	20 (18 for 1H and 1J)
Switching:	
3595 1C and 3595 1E	reed-relay, 3-pole
3595 1H, 3595 1J and 5000 1E	reed relay, 3 or 6 pole
Reed relay life:	>10 <sup>8</sup> operations
Maximum signal measured:	±12V
Maximum input voltage:	±14V
Overload protection, continuous:	50V
Max voltage between any two inputs:	
3595 1E, 3595 1J, 3595 51E:	500V
3595 1C, 3595 1H, 5000 1E, 3595 51C:	200V
Common mode, between IMPs	500V
Mean Time Between Failures :	64,000 (IMP) 69,000 (IMC)

**Measurement - All analogue measurement IMPs, IMCs**

Voltage dc (standard connector):	±12V
Current dc (with 100Ω shunt):	±20mA
Thermocouple types:	B,E,J,K,N,T,R,S
Thermocouple Cold Junction:	External or Automatic
Thermocouple open circuit detection:	programmable
Thermocouple condition monitoring:	loop resistance report (U-IMP and E-IMP only) (loop resistance ±0.1kΩ)

**3595 3D Optional High Voltage Connector (3595 1C and 1E only)**

Voltage dc:	±250V
Overload protection, continuous:	250V
Common mode rejection:	
dc:	>100dB
50 or 60Hz ±0.1%:	>100dB
Attenuation factor:	50:1

**Interference Rejection 3595 1A, 1C, 1E, 1H, 1J, 5000 1E IMPs  
3595 51A, 51C, 51E, 51H, 51J IMCs**

(Specifications are for 1kΩ imbalance in the input leads)

**20ms/16.67ms Integration time**

Normal mode:	50 or 60Hz ±0.1%	>60dB
Common mode:	dc:	>140dB
	50 or 60Hz ±0.1%:	>140dB
	50 or 60Hz ±1%:	>120dB

**5ms/4.17ms/1.25ms/1.04ms Integration time:**

Normal mode:	50 or 60Hz ±0.1%:	>0dB
Common mode:	50 or 60Hz ±0.1%:	>80dB

## Limits of Error

All limits of error shown in the following specifications are for 1 year at 20°±3°C (68°±5°F)

### DC Voltage

Temperature coefficient of ADC:  
 $<(0.0015\%rdg+0.2\mu V)$  per °C  
 3595 3D High Voltage Connector introduces  
 0.04% + 100µV rdg additional error.

### 20ms/16.67ms Integration time:

Range	Full Scale	Sensitivity	Limits of Error
20mV	22.000	1µV	±[0.02%rdg + 5µV]
200mV	220.00	10µV	±[0.02%rdg + 0.01%fs]
2V	2.2000	100µV	±[0.01%rdg + 0.01%fs]
12V	12.000	1mV	±[0.05%rdg + 0.01%fs]

### 5ms/4.17ms Integration time:

Range	Full Scale	Sensitivity	Limits of Error
20mV	22.000	2µV	±[0.02%rdg + 20µV]
200mV	220.00	20µV	±[0.02%rdg + 0.04%fs]
2V	2.2000	200µV	±[0.01%rdg + 0.04%fs]
12V	12.000	2.5mV	±[0.05%rdg + 0.04%fs]

### 1.25ms/1.04ms Integration time:

Range	Full Scale	Sensitivity	Limits of Error
20mV	22.000	8µV	±[0.02%rdg + 80µV]
200mV	220.00	80µV	±[0.02%rdg + 0.16%fs]
2V	2.2000	800µV	±[0.01%rdg + 0.16%fs]
12V	12.000	8mV	±[0.05%rdg + 0.16%fs]

### DC Current

Sensitivity, (using 100Ω shunt): 10nA  
 Error as for DC Voltage + error of shunt resistor + leakage currents

### Thermocouples

The following figures are based on 20ms/16.67ms integration times.

All specified in degrees Celsius.

Error quoted is conformity to IEC584 (BS4937).

(IMC 3595 51A, 51C and 51E must be in draught-free enclosure: no forced cooling)

Type	Mid Range	Error	Full Range	Error
B (Pt-30% Rh/Pt-6%Rh)	400 to 1820	<0.3	80 to 1820	<2.0
E (Ni-Cr/Cu-Ni)	-100 to 250	<0.3	-210 to 1000	<0.5
J (Fe/Cu-Ni)	-100 to 350	<0.3	-210 to 1200	<0.7
K (Ni-Cr/Ni-Al)	-100 to 450	<0.3	-200 to 1370	<1.0
N (Nicrosil/Nisil)	-180 to 1280	<0.3	-250 to 1300	<0.8
T (Cu/Cu-Ni)	-100 to 400	<0.3	-200 to 400	<0.5
R (Pt-13% Rh/Pt)	0 to 1600	<1.0	-50 to 1760	<2.0
S (Pt-10% Rh/Pt)	0 to 1760	<1.0	-50 to 1760	<1.5

Sensitivity, Types B,E,J,K,N,T: 0.1°C (0.18°F)  
 Sensitivity, Types R,S: 0.2°C (0.36°F)  
 Total thermocouple error equals Conformity plus voltage errors  
 Additional error when using automatic Cold Junction Compensation:  
 Range:-15° to 60°C (5° to 140°F): <0.4°C (0.72°F)  
 -20° to 70°C (-4° to 158°F):<0.6°C (1.08°F)  
 External Cold Junction range: -30°C to +80°C  
 (-22° to 176°F)  
 Open circuit detection threshold: 1.9kΩ ± 0.1kΩ

All Analogue IMPs are calibrated to the internationally unified volt.

Traceability is to the appropriate national standard.

## 3595 1B & 3595 51B Analogue Measurement IMP/IMC

Number of channels:	10
Switching:	solid-state, 6-pole
Maximum signal measured:	±2V
Overload protection, continuous:	50V
Max voltage between any input and any guard:	14V
Common mode between IMPs:	500V
Mean Time Between Failures, to MIL 217E:	106,000 hrs (IMP) 113,000 hrs (IMC)

### Measurement

Voltage dc:	±2V
Resistance, 3 & 4 Terminal:	0 to 2.5kΩ
Resistance Thermometer, 3 & 4 Terminal:	100Ω PRT
Strain:	3-wire, 1/4 -, 1/2 - and full-bridge
Sensor energisation:	0.8 or 4mA
Dummy supplied:	120Ω ±0.1% ±5ppm/°C

### Interference Rejection

(Specifications are for 1kΩ imbalance in the input leads)

#### 20ms/16.67ms Integration time:

Normal mode:	50 or 60Hz ±0.1%:	>60dB
--------------	-------------------	-------

Common mode:	dc:	>120dB
	50 or 60Hz ±0.1%:	>120dB
	50 or 60Hz ±1%:	>100dB

#### 5ms/4.17ms/1.25ms/1.04ms Integration time:

Normal mode:	50 or 60Hz ±0.1%:	>0dB
Common mode:	50 or 60Hz ±0.1%:	>80dB

## DC Voltage

Temperature coefficient of ADC:  $<(0.0015\%rdg+0.2\mu V)$   
per °C

### 20ms/16.67ms Integration time:

Range	Full Scale	Sensitivity	Limits of Error
20mV	22.000	1μV	$\pm[0.02\%rdg + 5\mu V]$
200mV	220.00	10μV	$\pm[0.02\%rdg + 0.01\%fs]$
2V	2.2000	100μV	$\pm[0.01\%rdg + 0.01\%fs]$

### 5ms/4.17ms Integration time:

Range	Full Scale	Sensitivity	Limits of Error
20mV	22.000	2μV	$\pm[0.02\%rdg + 20\mu V]$
200mV	220.00	20μV	$\pm[0.02\%rdg + 0.04\%fs]$
2V	2.2000	200μV	$\pm[0.01\%rdg + 0.04\%fs]$

### 1.25ms/1.04ms Integration time:

Range	Full Scale	Sensitivity	Limits of Error
20mV	22.000	8μV	$\pm[0.02\%rdg + 80\mu V]$
200mV	220.00	80μV	$\pm[0.02\%rdg + 0.16\%fs]$
2V	2.2000	800μV	$\pm[0.01\%rdg + 0.16\%fs]$

## Resistance

Temperature coefficient:  $<(0.003\%rdg+0.0007\%R_L)$   
per °C

The single lead resistance,  $R_L$ , only applies to 3-wire configurations.

Any lead resistance imbalance should be added to the error in 3-wire configurations.

### 20ms/16.67ms Integration time:

Range	Sensitivity	Limits of Error
25Ω	1.25mΩ	$\pm[0.03\%(rdg + R_L) + 6m\Omega]$
250Ω	12.5mΩ	$\pm[0.03\%(rdg + R_L) + 0.01\%fs]$
2.5kΩ	125mΩ	$\pm[0.02\%rdg + 0.03\%R_L + 0.01\%fs]$

### 5ms/4.17ms Integration time:

Range	Sensitivity	Limits of Error
25Ω	2.5mΩ	$\pm[0.03\%(rdg + R_L) + 24m\Omega]$
250Ω	25mΩ	$\pm[0.03\%(rdg + R_L) + 0.04\%fs]$
2.5kΩ	250mΩ	$\pm[0.02\%rdg + 0.03\%R_L + 0.04\%fs]$

### 1.25ms/1.04ms Integration time:

Range	Sensitivity	Limits of Error
25Ω	10mΩ	$\pm[0.03\%(rdg + R_L) + 96m\Omega]$
250Ω	100mΩ	$\pm[0.03\%(rdg + R_L) + 0.16\%fs]$
2.5kΩ	1.0Ω	$\pm[0.02\%rdg + 0.03\%R_L + 0.16\%fs]$

## Resistance Thermometer Device

Conformity for 100Ω RTD (PRT) is to IEC 751

Temperature coefficient:  $<(0.03+0.002\%R_L)^\circ C$  per °C

The error introduced by the single lead resistance,  $R_L$ , is an additional error which applies only to 3-wire configurations

Any lead resistance imbalance should be added to the error in 3-wire configurations.

### 20ms/16.67ms Integration time:

Range	Sensitivity	Limits of Error
-200 to 490°C	0.1°C	$\pm[0.4 + 0.1\%R_L]^\circ C$
490 to 600°C	0.1°C	$\pm[1.2 + 0.1\%R_L]^\circ C$

## Strain

Repeatability at constant temperatures over 24 hours is  $\pm 2\mu\epsilon$  for all configurations shown below.

Figures are for 120Ω gauges with gauge factor 2.

Measurement range for figures quoted: 0 to 10,000μϵ

### 20ms/16.67ms Integration time:

Type	Limits of Error	Temperature Coefficient
Full-bridge (8mA, 2 active gauges)	$\pm[0.06\%rdg + 6\mu\epsilon]$	$<(0.33\mu\epsilon + 0.004\%rdg)$ per °C
1/2 -bridge (4mA, 1 active gauge)	$\pm[0.06\%rdg + 8\mu\epsilon]$	$<(3.45\mu\epsilon + 0.004\%rdg)$ per °C
1/4 -bridge (4mA, 1 active gauge)	$\pm[0.06\%rdg + 14\mu\epsilon]$	$<(8.45\mu\epsilon + 0.004\%rdg)$ per °C

### 3595 1H, 1J, 5000 1E Multifunctional IMPs (6 pole analogue measurements)

Resistance, 3 and 4 terminal:

0 – 25kΩ

Resistance thermometer (RTD):

100Ω PRT (3 & 4 terminal)

10Ω Copper (4 terminal)

**Note:** 3- and 4-wire measurements use two channels

#### Resistance, 4-wire

Temperature coefficient: < 0.003%rdg per °C

#### 20ms/16 67ms Integration time:

Range	Full Scale	Limits of Error
25Ω	1.25mΩ	±[0.03%rdg + 6mΩ]
250Ω	12.5mΩ	±[0.02%rdg + 0.01%fs]
2.5kΩ	125mΩ	±[0.02%rdg + 0.01%fs]
25kΩ	1.25Ω	±[0.02%rdg + 0.04%fs]

#### 5ms/4.17ms Integration time:

Range	Full Scale	Limits of Error
25Ω	2.5mΩ	±[0.03%rdg + 24mΩ]
250Ω	25mΩ	±[0.03%rdg + 0.04%fs]
2.5kΩ	250mΩ	±[0.02%rdg + 0.04%fs]
25kΩ	2.5Ω	±[0.02%rdg + 0.04%fs]

#### 1.25ms/1.04ms Integration time:

Range	Full Scale	Limits of Error
25Ω	10mΩ	±[0.02%rdg + 96mΩ]
250Ω	100mΩ	±[0.02%rdg + 0.16%fs]
2.5kΩ	1.0Ω	±[0.02%rdg + 0.16%fs]
25kΩ	10Ω	±[0.02%rdg + 0.16%fs]

#### Resistance, 3-wire

Temperature coefficient: < [0.003%rdg + 0.03Ω] per °C

#### 20ms/16 67ms Integration time:

Range	Sensitivity	Limits of Error
1.5kΩ	125mΩ	±[0.02%rdg + 0.2Ω + 0.017%fs]
25kΩ	1.25Ω	±[0.02%rdg + 0.2Ω + 0.01%fs]

#### 5ms/4.17ms Integration time:

Range	Sensitivity	Limits of Error
1.5kΩ	250mΩ	±[0.02% + 0.2Ω + 0.07%fs]
25kΩ	2.5Ω	±[0.02%rdg + 0.2Ω + 0.04%fs]

#### 1.25ms/1.04ms Integration time:

Range	Sensitivity	Limits of Error
1.5kΩ	1.0Ω	±[0.02% + 0.2Ω + 0.3%fs]
25kΩ	10Ω	±[0.02%rdg + 0.2Ω + 0.16%fs]

#### Resistance, 2-wire

Temperature coefficient: < [0.003%rdg + 0.5Ω] per °C

#### 20ms/16 67ms Integration time:

Range	Full Scale	Limits of Error
500Ω	125mΩ	±[0.02%rdg + 50Ω + 0.05%fs]
25kΩ	1.25Ω	±[0.02%rdg + 50Ω + 0.01%fs]

#### 5ms/4.17ms Integration time:

Range	Full Scale	Limits of Error
500Ω	250mΩ	±[0.2%rdg + 50Ω + 0.02%fs]
25kΩ	2.5Ω	±[0.02%rdg + 50Ω + 0.04%fs]

#### 1.25ms/1.04ms Integration time:

Range	Full Scale	Limits of Error
500Ω	1.0Ω	±[0.02%rdg + 50Ω + 0.8%fs]
25kΩ	10Ω	±[0.02%rdg + 50Ω + 0.16%fs]

#### Resistance Thermometer Device (100Ω platinum), 4 wire

Conformity for 100Ω PRT (RTD) is to IEC 751

Temperature coefficient: < 0.03°C per °C

#### 20ms/16 67ms Integration time:

Range	Sensitivity	Limits of Error
-200 to 490°C	0.1°C	±0.4°C
490 to 600°C	0.2°C	±1.2°C

#### Resistance Thermometer Device (100Ω platinum), 3 wire

Temperature coefficient: < 0.2°C per °C

#### 20ms/16 67ms Integration time:

Range	Sensitivity	Limits of Error
-200 to 600°C	0.2°C	±2°C

#### Resistance Thermometer Device (10Ω copper), 4 wire only

Temperature coefficient (over -100 to 150°C):

< 0.02°C per °C

#### 20ms/16 67ms Integration time:

Range	Sensitivity	Limits of Error
-100 to 150°C	0.1°C	±0.3°C

### 3595 1D and 3595 51D Analogue Output IMP/IMC

Number of channels:	4
Output functions:	Bipolar dc voltage, unipolar dc current
Isolation between channels:	500V dc
Output noise:	<0.1% fs
Settling time to 1 bit:	75ms from transmission from host 40ms between channel values
Mean Time Between Failures to MIL 217E:	94,000 hrs (IMP) 103,000 hrs (IMC)

### Voltage Outputs

Range:	-10V to +10V
Resolution:	12 bits, 5.12mV
Minimum load resistance:	10k $\Omega$
Limits of error:	$\pm[0.1\%rdg + 10mV]$
Temperature coefficient:	$\pm[0.01\%rdg + 1mV]/^{\circ}C$

### Current Outputs

Range:	0 to 20mA
Resolution:	11 bits, 10.25 $\mu$ A
Output voltage compliance:	16V $\pm$ 1V at min. current, 10V at max. current
Current output limit:	25mA
Limits of Error:	$\pm[0.1\%rdg + 20\mu A]$
Temperature coefficient:	$[0.01\%rdg + 2\mu A]/^{\circ}C$

### Power Consumption

Voltage output:	1.2W
Current output:	3.3W



**3595 2A, 3595 52A Digital Input/Output IMP/IMC  
Channels 19, 20 on 3595 1H, 1J Universal IMPs**

Number of channels (may be input or output):	20 (2 on 3595 1H and 1J Universal IMPs)
Isolation, channel to channel or ground:	500V
Common mode between IMPs:	500V
Mean Time Between Failures, to MIL 217E:	145,000 hrs (IMP) 155,000 hrs (IMC)

**Inputs**

Voltage thresholds (0 and 1):	0.8 and 2.0V, or 3.0 and 9V
Maximum input:	25V or 100V
Min. input drive current:	600µA
Input sample rates, programmable:	20Hz; 1kHz; 10kHz; 100kHz
4 sample debounce is used for 20Hz and 1kHz rates	
Input functions	
Status:	
Events, (time of +ve or -ve edge), accuracy:	±1ms (not supported on 3595 1H, 1J Universal IMPs)
Frequency:	49kHz max
Frequency gate times, programmable:	0.01; 0.1; 1 or 10s
Period, resolution:	10µs
Periods averaged:	1; 10; 100; 1000; +ve or -ve pulse
Single shot minimum width:	10µs
Count (totalise or increment):	24 bits (>16 million)

**Outputs**

FET switch, which closes for a logic 1.	
Maximum withstand:	60V
Maximum sink per channel:	100mA
Energisation supply, built in:	5V, 20mA (not available on 3595 1H, 1J U IMP)

**Digital Input Counting and Event Capture (per channel)**

Maximum count rate per IMP is 15,000/s and is governed by software constraints. Thus for a worst-case input (all channels driven by the same signal) maximum count per channel is restricted to 750/s.

Maximum number of buffered events is 1,500 per IMP.

Sample Rates	20Hz	1kHz*	10kHz	100kHz
<i>Count Parameters:</i>				
Maximum frequency	2.4Hz	124Hz	4.9kHz	49kHz
Minimum period	400ms	8ms	200µs	20µs
Resolution of period	50ms	1ms	100µs	10µs
Counts max. rate	2.4/s	124/s	4900/s	15,000/s
Event capture rate#	5/s	100/s	100/s	100/s
Event resolution#	200ms	4ms	1ms	1ms

# Not available on 3595 1H or 1J Universal IMP

\* Indicates default setting

Figures assume an equal mark / space ratio.

## Frequency

Figures are for the default sample rate of 100kHz

Gate Time:	10ms	100ms	1s	10s
Min frequency	100Hz	10Hz	1Hz	0.1Hz
Resolution	100Hz	10Hz	1Hz	0.1Hz
Limits of Error	±[0.004%rdg + resolution]			

Frequency signals with a value less than 0.1Hz should be measured using event capture mode. All Limits of Error assume an equal mark / space ratio.

## Period

Figures are for the default sample rate of 100kHz

Periods Averaged:	1	10	100	1000
Resolution	10µs	1µs	0.1µs	0.01µs
Limits of Error	±[0.004%rdg + resolution]			

Period measurements have a programmable timeout applied. The timeout must be at least double the expected period. Timeouts of 200ms, 2s, 20s and 50s are available. The maximum period is therefore 25s. Period measurements greater than 25s should use the Event Capture mode. All Limits of Error assume an equal mark / space ratio.

## General Specifications

### IMP – Isolated Measurement Pods

#### Environment

Storage temperature:	-25° to 75°C (-13° to 167°F)
Operating temperature:	-20° to 70°C (-4° to 158°F)
Humidity, at 40°C (non-condensing):	95%
Vibration, operating for 2 hours:	5g, 11Hz to 500Hz
Otherwise, to Def. Std 66/31, Issue 01, Cat. IV.	

#### Packaging

Sealed aluminium casing to BS5490, IP55 (IEC 529) and NEMA ICS6 Class 4.	
IMP dimensions:	435mm x 215mm x 34.5mm (17.1" x 8.5" x 1.4")
Universal IMP dimensions: (U-IMP is also available in a standard IMP case)	470mm x 250mm x 48mm (18.5" x 9.8" x 1.9")
Protrusion of cable boots:	50mm (2")
Weight:	2.5kg (5.5lbs)

### IMC – Isolated Measurement Cards

#### Environment

Storage temperature:	-25° to 75°C (-13° to 167°F)
Operating temperature:	-10° to 60°C (14° to 140°F)
Humidity, at 40°C (non-condensing):	85%
Vibration, operating for 2 hours:	1g, 11Hz to 500Hz
Otherwise, to Def. Std 66/31 Issue 01 Cat. IV.	

#### Packaging

Dimensions:	420mm x 218mm x 30mm (16.54" x 8.58" x 1.18")
Protrusion of handles:	30mm (1.18")
Weight:	1.23kg (2.69lbs)

## 3595 2B, 3595 52B Switch Input/Output IMP/IMC

Number of channels (may be 1 to 32 inputs, 1 to 4 outputs): 32 total  
Isolation, channel to channel or ground: 120V  
Common mode, between IMPs: 500V  
Mean Time Between Failures, to MIL 217E:  
124,000 hrs(IMP)  
130,000 hrs(IMC)

#### Inputs

Voltage thresholds (0 and 1): 3.0 and 9.0V  
Resistance thresholds (0 and 1): 80kΩ and 500kΩ  
Maximum input: 120V  
Minimum input drive current: 600µA  
Input sample rate: 50Hz  
(4 sample debounce is used)  
Input functions: Status  
Events

Accuracy of event timing (+ve or -ve edge): ±20ms  
Maximum number of buffered events per IMP: 128

#### Outputs

FET switch, which closes for a logic 1.  
Maximum withstand: 60V  
Maximum sink, per channel: 100mA

#### Watchdog

Hardware Timeout: 1.2s  
Software Timeout, programmable: 1 to 255s

## Interfacing IMPS to a PC

A choice of two cards is now available to provide an interface between S-net, Solartron's two-wire multidrop communications network, and your PC bus.

1. The 3595 4B which fits into an ISA expansion slot in the PC.
2. The 3595 4C which fits into a PCI bus expansion slot.

These interfaces provide:

- Control commands for measurement set-up
- Measurement initiation
- Measured data retrieval
- Synchronised time stamping across the network
- DC Power to all connected IMPs

Full timing control and error checking are performed on the data.

Either card occupies one slot in the PC, and contains its own data buffering. Data is exchanged with the PC via the 64K dual-port RAM which is divided into 512byte pages, each page dealing with a particular aspect of IMP operation.

Several cards, each driving a separate S-Net, may be present in one PC if required. Each S-net supports up to 50 IMPs.

The interface can power up to 5 IMPs via the PC's internal supply; for larger systems an external power supply must be connected. This power supply can be situated by the PC, using the S-net to supply each IMP, or may be local to the IMPs, supplying power directly to each IMP.

## Specification

### 3595 4B ISA Interface Card

#### Connections

62-way edge connector for ISA expansion bus

9-way D-type female connector for S-net

9-way D-type male connector for external power.

#### PC Operating requirements

Address space 512 bytes, base address selectable

Address selection 80000H to FFE00H in steps of 512 bytes

IRQ (Interrupts) selectable from IRQ2,3,5-7,10-14 or disabled

#### Physical

(Half-length PC I/O card)

Length 179mm / 7.05in.

Height 130mm / 5.12in.

Width 25mm / 1.0in.

Weight 0.2kg / 0.44lbs

### 3595 4C PCI Interface Card

#### Connections

124-way edge connector for PCI expansion slot bus

9-way D-type female connector for S-net

9-way D-type male connector for external power.

#### Physical

(Half-length PC I/O card)

Length 173mm / 6.8in.

Height 107mm / 4.2in.

Width 20mm / 0.8in.

Weight 0.2kg / 0.44lbs

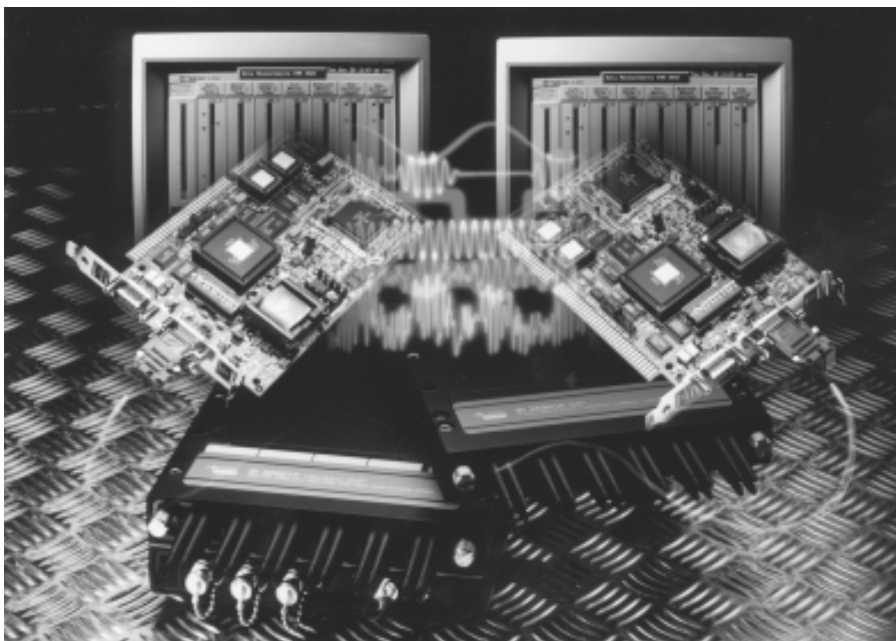

## General – Both interface cards

### S-Net Communication Capability:

Maximum number of IMPs	50
Max. length of cable	1,500m. (1 mile) special / cable required over 1Km

### Power supply requirements

#### Power from PC supply:

PC Loading:	5V: 2.5W maximum
	12V: 1.2W for each IMP (3595 1A to 1E & 2A, 2B)
	1.8W for each Universal IMP (3595 1H & 1J)
Maximum number of IMPs:	5

#### External power supply:

Output voltage:	12V to 50V dc (see note)
Supply ripple:	<100mV rms
Power drain:	1.2W per IMP (1.8W per Universal IMP)
Maximum number of IMPs:	50

**Note:** Number of IMPs that can be powered depends on length of S-net cable, gauge of cable and distribution of IMPs along the cable.

See “Communication Cable Selection for IMP Networks”.

### Environment

Temperature	
Operating	0° to 55°C (32° to 131°F) @ 50%RH
	0° to 45°C (32° to 113°F) @ 95%RH
Storage	-40° to 70°C (-40° to 158°F)

#### Accessories supplied: with 3595 4B and 4C

10 metres 24 gauge S-Net cable
One 9-way D-type socket
One 9-way D-type plug
Two S-Net terminators

#### One CD Part No. 3595 5840 containing:

##### Handbooks

3595 2061 IMP 3595 Installation Guide
3595 2232 PC ISA to S-Net interface, 3595 4B
3595 2350 PC PCI to S-Net interface, 3595 4C
3595 2245 IMPVIEW 3595 Operating manual

##### Software

3595 74A IMPVIEW Installation disk
35957H 32 bit Windows drivers
3595 75A Labview/Bridgeview drivers

### Solartron Mobrey Limited

158 Edinburgh Avenue Slough Berks UK SL1 4UE  
Tel: 01753 756600 Fax: 01753 823589  
e-mail: sales@solartron.com www.solartronmobrey.com



Solartron Mobrey GmbH  
Solartron Mobrey Ltd  
Mobrey sp z o o  
Solartron Mobrey AB  
Mobrey SA  
Solartron Mobrey SA-NV  
Solartron Mobrey

Deutschland tel: 0211/99 808-0  
China tel: 021 6353 5652  
Polska tel: 022 871 7865  
Sverige tel: 08-725 01 00  
France tel: 01.34.30.28.30  
Belgium tel: 02/465 3879  
USA tel: (281) 398 7890



The right is reserved to amend details given in this publication without notice